

# Thermal barrier coating effect on stress and temperature distribution of diesel engines cylinder heads using a two-layer viscoelasticity model with considering viscosity effects

Hojjat Ashouri<sup>1</sup>

<sup>1</sup>Sama technical and vocational training college, Islamic Azad University , Varamin Branch, Varamin, Iran.

Email: ashori@samav-ac.ir

## Abstract

This paper presents finite element analysis (FEA) of a coated and uncoated cylinder heads of a diesel engine to examine the distribution of temperature and stress. A thermal barrier coating system was applied on the combustion chamber of the cylinder heads, consists of two-layer systems: a ceramic top coat (TC), made of yttria stabilized zirconia (YSZ), ZrO<sub>2</sub>-8%Y<sub>2</sub>O<sub>3</sub> and also a metallic bond coat (BC), made of Ni-Cr-Al-Y. The coating system in this research comprises 300 μm zirconium oxide TC and 150 μm BC. The three-dimensional model of the cylinder heads was simulated in abaqus software and a two-layer viscoplasticity model was utilized to investigate the elastic, plastic and viscous behavior of the cylinder heads. The elastic and plastic properties of BC and TC layers were considered and the effect of thermal barrier coatings on distribution of temperature and stress was investigated. The aim of this study is to compare the distribution of temperature and stress in the coated and uncoated cylinder heads under thermo-mechanical loads. The results of FEA showed that the thermal barrier coating system reduces the temperature about 53°C because of its lower thermal conductivity. As a result, the cylinder head tolerates lower temperature and fatigue life will increase. The results of thermo-mechanical analysis indicated that the stress in the coated cylinder head decreased approximately 24 MPa for the sake of depletion of temperature gradient which can lead to higher fatigue lifetime. Viscous strain was significant and its amount is not negligible.

**Keywords:** thermal barrier coating, finite element analysis, cylinder heads and valves bridge

## 1. Introduction

Cylinder heads are the important parts of the internal combustion engines which are under thermo-mechanical stresses for the sake of their working type [1-6]. Therefore, selection of materials is of paramount importance since they must have sufficient mechanical strength at high temperatures to be able to withstand cyclic stresses caused by heat and pressure [2,3,6,7]. High output capacity, low fuel consumption, low emission and reducing the cost of maintenance are among the restrictions making the design of cylinder heads a complicated task [3]. Aluminum-Silicon is a casting alloy which has

extensive use in the automotive industry, especially in cylinder heads of diesel engines. These materials have been replaced by a variety of cast iron which were previously used in the manufacture of cylinder heads [1].

Cylinder heads are exposed to thermal and mechanical loads. The temperature difference, which is the result of turning the engine on and off, begets thermo-mechanical fatigue (TMF) loads on the cylinder heads [1,3,8,9,10] and consequently reduces their lifetime, especially in thinner regions. The crucial regions include the valves bridge and areas near spark plugs and injectors [2,11]. Many researchers have carried out a large number of studies on design of diesel engines with lower heat rejection

(LHR) by using thermal barrier coating (TBC). The diesel engine generally offers better fuel economy than its counterpart petrol engine. Even the diesel engine rejects about two thirds of the heat energy of the fuel, one-third to the coolant, and one third to the exhaust, leaving only about one-third as useful power output. Theoretically, if the heat rejected could be reduced, then the thermal efficiency would be improved, at least up to the limit set by the second law of thermodynamics. LHR engines aim to do this by reducing the heat lost to the coolant [12,13,14].

Typically, the thermal efficiency of diesel engines is low and consequently huge amount of fuel energy wastes. Therefore, the design of advanced engines with low heat dissipation has considerably increased because of the strict regulations in fuel economy and engine emissions. One way to improve the thermal efficiency in diesel engines is using thermal barrier coatings (TBCs) [12,15,16]. TBCs can be applied to the combustion chamber of diesel engines in order to allow higher combustion temperatures which increase the thermal efficiency or to achieve lower base metal temperatures. This can cause an increase in fatigue life of high temperature components and also reduction in fuel consumption and some emissions such as hydrocarbons [17,18,19].

TBCs used in diesel engine components comprise two main layers, namely top coat which is mostly made of zirconium oxide and a metallic bond coat [15,20,21]. In this research, the composition of TC is  $ZrO_2-8 \text{ wt.}\% Y_2O_3$  and that of BC is Ni-Cr-Al-Y. The thicknesses of BC and TC layers are considered as  $150 \mu\text{m}$  and  $350 \mu\text{m}$ , respectively [22].

Aluminum cylinder heads must be adequately robust to tolerate gas pressure, assembly loads and high temperature resulting from ignition to avoid cracking the valves bridge [7]. Thermo-mechanical loading cylinder heads can only be controlled through modern cooling systems or protective coatings such as TBC that reduces heat stress and thereby reduces the temperature gradient [23].

The biggest weakness of the thermal barrier coating systems is the interface between the two layers of metal and ceramic. This area undergoes high stress due to the difference of thermal expansion coefficient between the two metal and ceramic layers. Therefore, damage generally starts from this area in thermal barrier coatings. Accelerating the destruction and detachment of the coatings, oxidation of metal layers is another reason for thermal barrier coatings destruction. As a result, the studies on thermal barrier coating systems are focused on improving fracture toughness and adhesion strength in order to increase the service life and reliability of thermal barrier coatings at high temperature [21,24,25].

Preliminary researches on the application of the thermal barrier coating in diesel engines were carried out by kamo and bryzik, kamo and sekar and kamo et al. in 1978 to 1989. Their experiments revealed that thermal barrier coatings reduce fuel consumption, improve thermal efficiency, increase power, reduce noise, reduce maintenance costs, improve reliability and durability, reduce emissions and amplify engine life and the ability to use several types of fuel [26-29,30,31]. These results are confirmed in the experiments conducted by winkler et al. and winkler and Parker [32,33].

Arment et al. and Modi investigated the effect of thermal barrier coating on the performance of diesel engines. Their researches proved that the thermal barrier coatings reduce fuel consumption [16,34].

The effect of thermal barrier coatings on engine emissions were studied by buyukkaya et al. and Ramu and Saravanan. Their experiments proved that the thermal barrier coatings reduce unburned hydrocarbons, carbon monoxide and oxides of nitrogen [13,17].

Asghari and salimi, ranjbar-Far et al., wang et al. and rezvani rad et al. studied the effect of thermal barrier coatings on stress distribution in experimental samples and observed the reduction of stress distribution in the substrate of experimental samples with thermal barrier coatings. The maximum stress occurred in BC layer [20,35,36,37].

In another attempt, temperature and stress distributions in coated pistons of gasoline engines were examined by cerit. His analysis proved that the surface temperature of the pistons with 0.5mm thickness coating was 34 percent more than the surface temperature of pistons which were not coated [38].

Comparing temperature distribution of coated pistons in a gasoline engine proved that YSZ is the best coating for the pistons to reduce unburned hydrocarbons [39].

Thermal analysis of two pistons of a gasoline engine which were coated in metal thermal barrier coating and zirconium were carried out by marr et al. Their study showed that metal thermal barrier coating and zirconium reduce the transfer of heat flux from the piston crown to its bottom about 69% and 77% respectively, compared to the pistons which were not coated [40].

Cerit and coban analyzed thermal stress and temperature distribution in coated pistons of a diesel engine. The temperature at the surface of the coated region was significantly higher than that of the uncoated piston surface. Increase in the maximum temperature at the crown center, compared with the uncoated piston, was 32.7%, 55.8%, 72.5% and 84.8%

for 0.4 mm, 0.8 mm, 1.2 mm and 1.6 mm thickness coating, respectively. It is clear that a higher combustion chamber temperature is provided by means of TBC. As a result, thermal efficiency of the engine increases. Moreover, reduction of the piston (substrate) surface temperature has a positive effect on engine performance [41].

Temperature distribution and heat flux of coated pistons of a turbocharged diesel engine were evaluated by saad et al. The reduction of temperature distribution and heat flux were reported respectively about 219°F and 1Btu/min-in<sup>2</sup> in the substrate of coated pistons [42]. Thermal analysis of both steel and aluminum coated pistons of a diesel engine was performed by buyukkaya and cerit. Their analysis showed that the thermal barrier coatings increase the surface temperature of steel and aluminum pistons respectively about 35 and 48 percent, compared to the uncoated pistons [43].

Du et al. investigated the effect of thermal barrier coating on temperature distribution and the stress in pistons of a diesel engine. The results of their study disclosed that thermal barrier coatings decrease distribution of temperature and stress in the substrate of pistons, hence, the fatigue life of pistons increases. Meanwhile, the maximum stress was observed in BC layer [44].

Hejwowski and weronski inspected effect of thermal barrier coatings on the performance of a diesel engine and they found out that the optimum thickness for thermal barrier coatings is less than half a millimeter [19].

Comparing stress distribution in several pistons with different coatings revealed that YSZ is the best thermal barrier coating for pistons to withstand thermal fatigue tests [45].

Das et al. and Sivakumar and Kumar evaluated the effect of pistons with zirconium coating on the performance of a diesel engine, they come to the conclusion that the thermal barrier coating reduces fuel consumption, improves thermal efficiency and reduces unburned hydrocarbons and carbon monoxide [46,47].

Ekström et al. investigated the effects of thermal barrier coatings on temperature distribution in the exhaust manifold of a diesel engine. Their research uncovered the fact that thermal barrier coatings reduce the temperature distribution in the substrate of the exhaust manifold about 219°F [48].

Thermo-mechanical analysis of coated cylinder heads of a diesel engine was the subject of another study by Rezvani rad et al. They illustrated that the temperature of the substrate reduced up to 80°C when the TBC system was used. Also, the Von-Mises stress decreased about 20MPa by using the TBC system. In

the coated cylinder head, maximum stress occurred in the bond coat layer [49].

Buyukkaya performed the thermal analysis of steel and aluminum coated pistons. His research indicated that the surface temperature of the steel piston was almost 14% lower than the aluminum piston [50].

The effect of coated pistons on the performance of a diesel engine was investigated by rupangudi et al. They reported augmentation of volumetric and mechanical efficiency and depletion of fuel consumption. The exhaust temperature for engine with coated piston was about 40°C in excess as compared to the standard engine [15].

Quazi and parashar studied the effect of thermal barrier coating on performance and emissions of off road vehicle. Their experiments proved that zirconium oxide is appropriate coating for enhancing specific fuel consumption and thermal barrier coatings reduce unburned hydrocarbons and carbon monoxide [12].

Danielson et al. did thermo-mechanical analysis of two cylinder head without coatings and a cylinder head of LHR engine. Their analysis indicated that some regions of the two uncoated cylinder heads entered into yield region. Hence, fatigue cracks appear in them. Thermal barrier coating caused all regions of the engine's cylinder head of LHR motor to be in elastic zone [14].

According to the introduction, due to the lack of information on the behavior of hardening, softening and viscosity of materials the analysis of pistons and cylinder heads is mostly based on simple models of material behavior like elastic-plastic and the effects of viscosity and creep of pistons and cylinder heads are less taken into consideration. In addition, few studies have been conducted on the effect of thermal barrier coating on distribution of temperature and stress of cylinder heads. Aluminum alloy has creep behavior at about 300°C and viscosity should also be taken into accounted [9,10,51,52]. The main objective of this study is to simulate the thermo-mechanical behavior of coated cylinder heads based on the two-layer viscoplasticity model. viscous properties (the creep phenomenon) in coating layers occur at higher temperatures more than 600°C[36]. In some analyses, it is assumed that temperature changes have no effect on the stress-strain curves and thermo-mechanical analysis of pistons and cylinder heads is non-coupled. Since changes in temperature influence on stress-strain curves, the thermo-mechanical analysis of cylinder heads in this study is coupled.

## 2. The material and its behavioral model

In this study the cast alloy of aluminum-silicon-magnesium has been used to simulate the thermo-

mechanical behavior. The alloy is known as A356.0 or AlSi7Mg0.3 which is applied in diesel engines cylinder heads [8,21]. The chemical composition of the A356.0 is 7.06 wt.% Si, 0.37 wt.% Mg, 0.15 wt.% Fe, 0.01 wt.% Cu, 0.02 wt.% Mn, 0.13 wt.% Ti, and Al remainder [8,20].

The two-layer viscoplasticity model divides the elastic and viscosity effects into two elastic-viscous and elastic-plastic networks. As displayed in Figure 1, this model is presented by Kichenin [53]. This model makes the cyclic stress-strain behavior of the material predictable with reasonable accuracy [54].

This model consists of a network of elastic-plastic parallel to a network of elastic-viscous.

Plastic deformation and creep can be seen in structures such as cylinder heads of engines which are under assembly loads and temperature fluctuations. The two-layer viscoplasticity model is the best to examine the response of materials such as aluminum cylinder heads which have remarkable dependent behavior on temperature and plastic at high temperatures [4,6,8,54]. This model is in good agreement with results of experimental and thermo-mechanical test of A356.0 alloy [8].

The material behavior of different Aluminum-Silicon casting alloys was described by the nonlinear kinematic/isotropic hardening model of Abaqus software [52].

In the plastic network nonlinear kinematic/isotropic hardening model is applied which predicts the behaviors such as hardening, softening, creep and mean stress relaxation and and it is a suitable model for the plastic behavior of materials [8,54].

Kinematic hardening has both linear and nonlinear isotropic/kinematic model. The first model can be used with Mises or Hill yield surface while the second one can only be used with the Mises yield surface and it is the most accurate and comprehensive model to examine some issues with cyclic loading including cylinder heads of engines. The kinematic hardening model assumes that the yield surface, proportional to the value of  $\alpha$ , moves as back stress in yield zone but it does not deform [55]. Abaqus software uses ziegler linear model [55] to simulate this model as following equation shows:

$$\dot{\alpha} = C \frac{1}{\sigma_0} (\sigma_{ij} - \alpha_{ij}) \dot{\epsilon}^{PL} + \frac{1}{C} \dot{C} \alpha_{ij}$$

Where C is kinematic hardening modulus, "C" is of exchange rate of C in temperature and " $\dot{\epsilon}^{PL}$ " is the rate of equivalent plastic strain. In this model  $\sigma^0$  (the size of the yield surface) remains constant. In other words,  $\sigma^0$  is always equal to  $\sigma_0$  (that is yield

stress in zero plastic strain) remain constant. Nonlinear isotropic/kinematic hardening model includes motion of yield surface proportional to the value of  $\alpha$  in stress zone and also changes in the size of yield surface is proportional to the plastic strain [55]. This model has been extracted from Chaboche experience [56,57]. In order to introduce this model a nonlinear term is added to equation (1) to indicate the size of yield surface [55].

The Abaqus software uses nonlinear isotropic/kinematic hardening model as following equation shows:

$$\dot{\alpha} = C \frac{1}{\sigma_0} (\sigma_{ij} - \alpha_{ij}) \dot{\epsilon}^{PL} - \gamma_{ij} \dot{\epsilon}^{PL} + \frac{1}{C} \dot{C} \alpha_{ij}$$

Where C and  $\gamma$  are material constants. In order to introduce this model in Abaqus software the isotropic and the kinematics parts are required to be defined separately [8]. In order to define the isotropic part the equation (3) is used in which b and  $Q_\infty$  are material constants [54].

$$\sigma^0 = \sigma_0 + Q_\infty (1 - \exp(-b \dot{\epsilon}^{PL}))$$

The overall back stress is computed from the relation (4) [55]:

$$\alpha = \sum_{k=1}^N \alpha_k$$

In equation (4) if we consider N equal to 3, the hardening variable is divided into three parts which increases the accuracy of the model [8].

Norton-Hoff law is used viscous network in order to consider the effect of strain rate, the equation of which is the following [58]

$$\dot{\epsilon}_v = A(\sigma_v)$$

Where the  $\dot{\epsilon}_v$  is viscous strain rate, A and n are material constants and  $\sigma_v$  is the viscous stress.

According to equation (6) the rate of the elastic modules in the two viscous and plastic networks is express by f. Where  $k_v$  and  $k_p$  are elastic modules in the elastic-viscous and elastic-plastic networks respectively [54].

$$F = \frac{k_v}{k_v + k_p}$$

### 3. The finite element model and material properties

Traditionally, optimization of engine components such as cylinder heads was based on building a series of physical prototypes, and performing a series of different experiments and tests. Unfortunately, this method is time consuming and building a prototype in the early stages of the design is arduous. Many samples must be constructed and tested in order to achieve the precise design. This process is costly. These problems have been resolved using FEA to evaluate the effectiveness of various designs. This technique is accepted for the design and development of geometrically complex components such as cylinder heads in a shorter period and with the least cost. Cylinder heads are complex and challenging components of engines, for which the Finite Element (FE) analysis plays a critical role in optimization [11]. TMF analysis of each component needs the cyclic stress-strain distribution. Diesel engines hot components hold complex geometry and loading, and the applying analytical methods for the detection of stress-strain distribution in them is impossible. Many researchers have used finite element method to obtain stress-strain distribution in of geometrically complex components [59]. Nowadays, simulation techniques are substitute to validation tests so as to decrease the cost and time of production [5]. Cylinder heads examined in this study are shown in Figure 2.

Cylinder heads have three valve ports, each with an embedded valve seat; two valve guides; and four bolt holes used to secure the cylinder heads to the engine blocks. Cylinder heads are made of aluminum alloy (A356.0). The two valve guides are made of steel, with a Young's modulus of 106 GPa and a Poisson's ratio of 0.35. The valve guides fit tightly into two of the cylinder heads and their behavior is presumed elastic. The three valve seats are made of steel, with a Young's modulus of 200 GPa and a Poisson's ratio of 0.3. The valve seats are press-fit into the cylinder head valve ports. This is accomplished by defining radial constraint equations [60].

The FE model consists of 30122 first-order 8-node, heat transfer and 3D stress, brick elements from which 8000 elements belong to TBC system. Cylinder heads loading was done in two phases involving thermal analysis and mechanical analysis.

The values of  $f$ ,  $n$ ,  $A$  and  $Q_{\infty}$  were extracted from the experimental results of A356.0 from source [8] and they were entered into the Abaqus software.

There are several methods to insert the values of  $C$  and  $\gamma$  into Abaqus software that one of them is entering yield stress at plastic strain using the midlife cycle stress at plastic strain using the midlife cycle [8]. The yield stress at plastic strain was extracted from source [8], by means of the results of conducted experiments on A356.0 and entered into the Abaqus software.

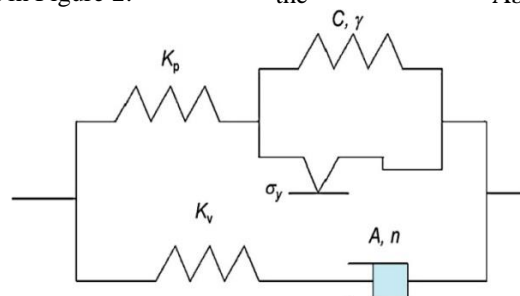

Fig1. The two-layer viscoplasticity model [54]

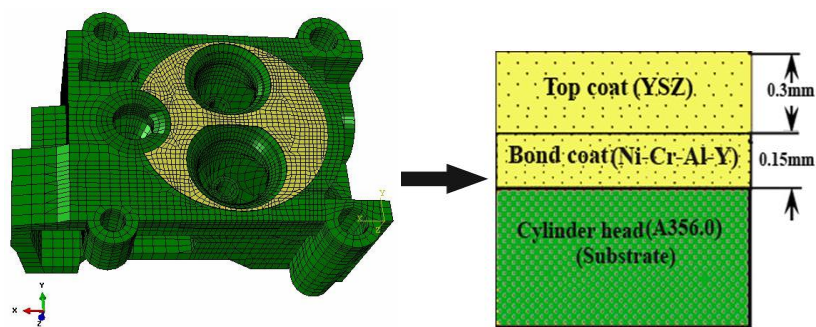

Fig2. The FE model of the coated cylinder head

## 4. Results and Discussion

### 4.1 Thermal Analysis

Thermal stresses in the cylinder heads are the dominant stresses, leading to low cycle fatigue in the cylinder heads. Low cycle fatigue of cylinder heads is caused by repeated start-up and shut-down cycle of the engine [9,10]. The main part of cylinder heads stresses is the result of the thermal loading and the rest is caused by the combustion pressure and mechanical constraints [11]. Therefore, thermal loading is the most important loading in the thermo-mechanical analysis of cylinder heads. Knowing the precise distribution of temperature in the cylinder heads increases the accuracy of thermal analysis. Accurate prediction of the temperature of the engine is very crucial and increases the precision of the FEA results. As the accuracy of thermal analysis increases the accuracy of mechanical analysis and fatigue life estimation rises [9,10]. In FE simulation the valves bridge, where the greatest thermal concentration exists, is subjected to thermal loading ranging from a minimum of 35°C to a maximum of 300°C [6]. The temperature distribution when the cylinder heads are heated to its peak value is shown in Figure 3. It is maximized at the valve bridge when there are no coating layers. Thermal loading has a considerable effect on the fatigue life and the temperature field identifies critical regions [5]. This thermal loading is applied for the uncoated cylinder heads.

In the coated cylinder heads, TC face temperature is considered as 350°C which is about 50°C hotter than the maximum temperature region of the valve bridge in uncoated cylinder heads. This temperature rise is due to have better thermal efficiency with TBC

systems [21]. Then, a thermal analysis is done to find the temperature distribution in all layers. Contour results of the temperature distribution in the coated cylinder heads are shown in Figure 4. This figure shows that although surface temperature of the ceramic layer of coated cylinder heads is about 50°C higher than the cylinder heads without coating, thermal barrier coating system reduces surface temperature of the substrate of coated cylinder heads about 53°C (from 308°C to 254.9°C).

Plastic deformation and creep are observed under such conditions. The two-layer viscoplasticity model is ideally suited to examining the response of materials in these conditions [4,6, 8,54]. The cyclic thermal loads are obtained by performing an independent thermal analysis. In this analysis three thermal cycles are applied to obtain a steady-state thermal cycle. Each thermal cycle involves two steps: heating the cylinder heads to the maximum operating temperature and cooling it to the minimum operating temperature using the \*CFLUX and \*FILM options. The nodal temperatures for the last two steps (one thermal cycle) are assumed to be a steady-state solution and results are stored for use in the subsequent thermal-mechanical analysis [6].

The temperature in this region (node 50420) is shown in Figure 5 as a function of time for a steady-state cycle, representing a cycle of turning the engine on and off. This figure demonstrates that thermal barrier coating system declines the temperature distribution in the valves bridges. The lower temperature of the flame and the gradient temperature of the parts of cylinder heads, the less thermal stress. Thus, low-cycle fatigue life of the cylinder heads which is mainly affected by thermal fatigue will increase [61].

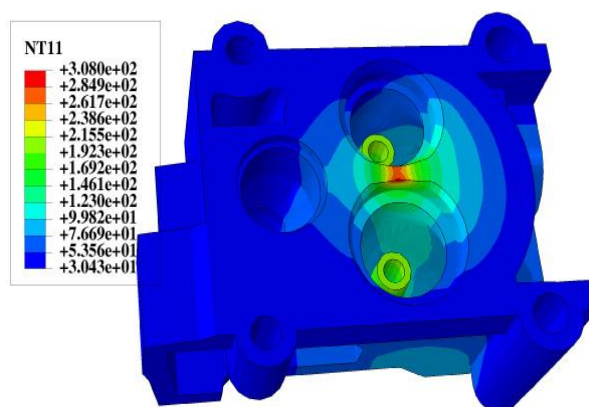

Fig3.. The temperature distribution in the uncoated cylinder head

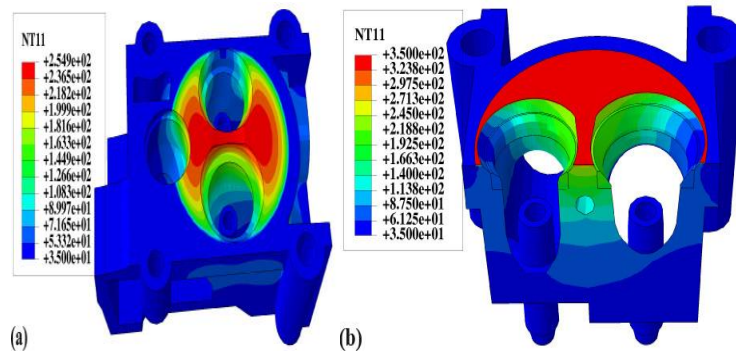

Fig4. The temperature distribution in the coated cylinder head: (a) without TBC, (b) with TBC

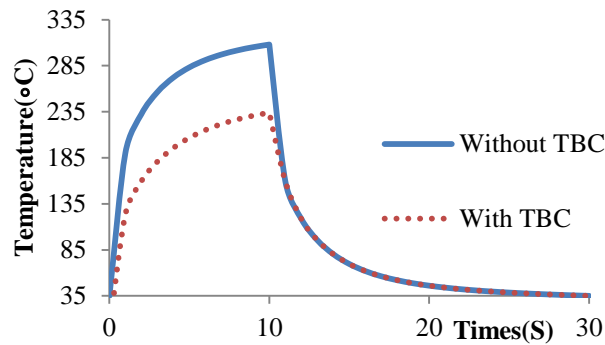

Fig5. The temperature at node 50420 versus time.

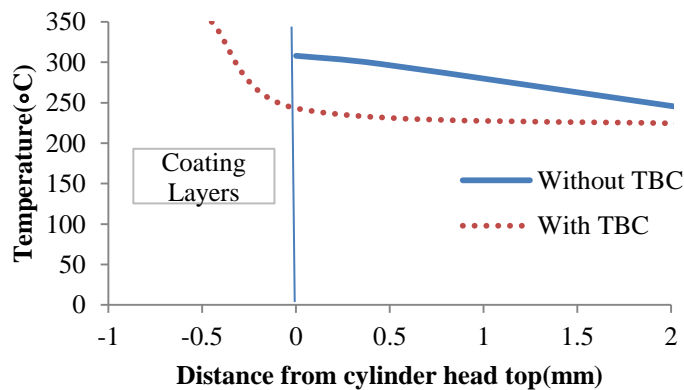

Fig6. The temperature distributions through the thickness at the valve bridge

The valve bridge is a crucial region [2, 3, 7, 11]. Based on the source [4] the first fatigue cracks can be seen at the hottest spot of cylinder heads. This region

is located in the valves bridge. The Temperature distributions through the thickness at the valve bridge are demonstrated in Figure 6. The temperature

gradient through the thickness changes from 308°C to 254°C for the uncoated cylinder heads. For the coated cylinder heads, although this temperature gradient is higher due to the TBC system, the temperature in the substrate changes from 249°C to 231°C. It means that maximum temperature of aluminum alloy reduces up to 59°C (from 308°C to 249°C) by using the TBC system. This can lead to lower stress values in the aluminum alloy substrate. Thus, the fatigue lifetime of the cylinder heads can be improved [14,22,44].

Given that the main task of thermal barrier coatings is preventing heat transfer to the substrate, thermal insulation and low thermal conductivity are among the most important factors in assessing the performance of these coatings and their practical development. That means insulating the substrate against high temperatures. In other words, using the thermal barrier coatings, reduce heat transfer to the substrate keeping it at lower temperature [62]. Therefore, the engine can bear higher temperature leading to increase of its efficiency [15, 18]. This helps engine longevity and cuts maintenance costs [32, 33].

#### 4.2 Mechanical analysis

Mechanical analysis was carried out in two stages. In the first stage the three valve seats are press-fit into the corresponding cylinder heads valve ports. A static analysis procedure is used for this purpose. The cyclic thermal loads are applied in the second analysis step. It is assumed that the cylinder heads are securely fixed to the engine blocks through the four bolt holes, so the nodes along the base of the four bolt holes are secured in all directions during the entire simulation [6]. In the second stage the thermal cycle loads were applied so that the material behavior reaches steady state. Von-Mises stress distribution at the end of the second stage is shown in Figure 7 for the uncoated cylinder head. The maximum stress, the same as maximum temperature, occurred in the valves bridge.

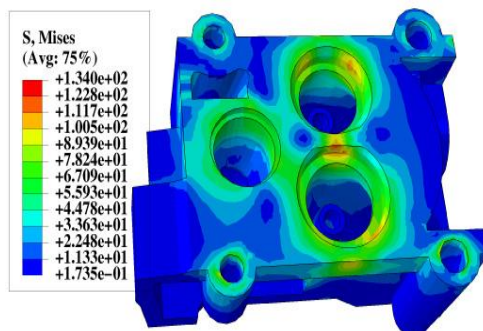

Fig7. The Von-Mises stress distribution in the uncoated cylinder head

Stress contour results for the coated cylinder heads are presented in Figure 8(a). As shown in stress contours, maximum stress occurs in the BC layer (Figure 6(b)). This corresponds to the results by [20,35,36,37].

Figure 8(a) demonstrates that thermal barrier coating system declines the stress distribution in the valves bridge. The location of cracks in cylinder heads is in the valves bridge. This region endures maximum stress due to the less thickness of material and high temperature caused by lack of proper cooling. Ergo, the cylinder heads will crack [2,4,51]. The stress reduction value in the coated cylinder head is about 24 MPa which can lead to higher fatigue lifetimes in comparison to the uncoated cylinder head.

The value of Von-Mises stress in the BC layer is calculated about 270 MPa (Figure 8(b)). Comparing this result to the yield stress of the BC layer can be a criterion for the crack initiation. This can lead to the crack initiation. In such cases, the failure mechanism in TBC system is the separation of the BC layer from the substrate under thermal fatigue tests. This is due to their material properties mismatch [20, 21]. In thermal barrier coating system, non-compliance of thermal expansion coefficients of the BC and TC layers, causes high stress at the interface between the two layers. According to reports, the weakest area in thermal barrier coating system is the interface of the two BC and TC layers and in the fatigue tests, this area endured failure [24,25,63,64]. The interface of the two BC and TC layers is considered as stress concentration area and fatigue cracks initiation in this area [20,64].

Figure 9 demonstrates that thermal barrier coating system declines the stress distribution in the valves bridge. The value of Von-Mises stresses in the substrate, first reduces by using TBC systems (which are caused by a decrease in the temperature) and then increases due to the complex geometry and multiaxial loadings [66].

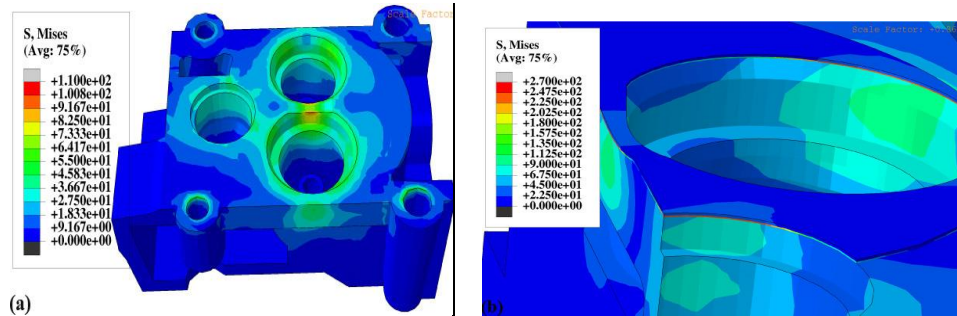

Fig8. The Von-Mises stress distribution in the coated cylinder head: (a) without TBC, (b) with TBC

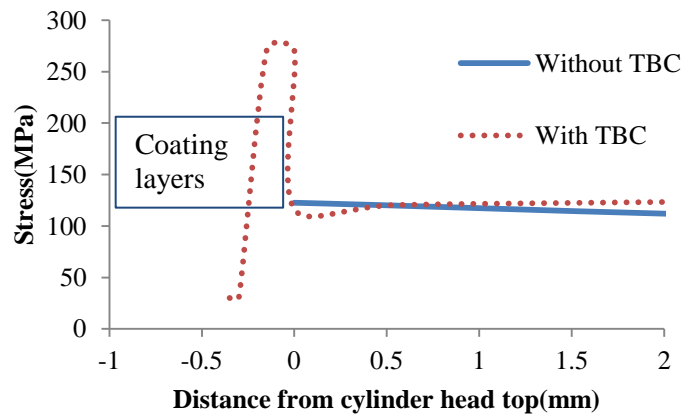

Fig9. The stress distributions through the thickness at the valve bridge

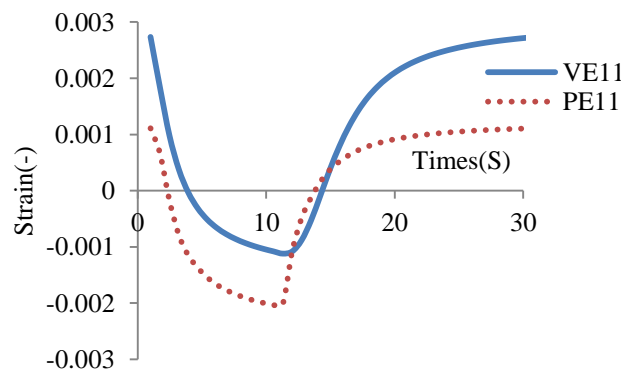

Fig10. The plastic and viscous strain for point 1 of element 50152 versus time

## 6. Conclusion

The aim of this study is to investigate the distribution of temperature and stress in coated cylinder heads of diesel engines using a two-layer viscoplasticity model. The results of FEA demonstrated that the temperature distribution in the coated cylinder head dwindles approximately 53°C by virtue of lower thermal conductivity of thermal barrier coating system. Temperature distribution in the coated cylinder head proved that the most of the heat load is concentrated in the upper area of thermal barrier coating and the substrate has lower temperature. Therefore, the cylinder head endures less temperature and fatigue life will increase. The thermo-mechanical analysis proved that Von-Mises stress decreases about 24 MPa by using the TBC system, which can lead to higher fatigue lifetime. Due to the noncompliance of thermal expansion coefficients of BC and TC layers, the maximum stress in thermal barrier coating system occurred in the BC layer. Hence, there is a possibility of failure of thermal barrier coating in BC layer which corresponds to the results of the failure sources of thermal barrier coating under fatigue tests.

The valve bridge is a critical region and fatigue cracks initiation in this area. Thermal barrier coating system reduces the distribution of temperature and stress in the valve bridge and the fatigue life of the cylinder head increases. Applying FEA and computer simulation in stress analysis and heat distribution in coated cylinder heads lead to reduction of production costs and substantially contribute to obtaining optimum thermal barrier coatings. Viscous strain was significant and its effect is not negligible. Thus, viscous properties must be considered in the thermo-mechanical analysis of cylinder heads. Temperature is effective on stress-strain curves, and the thermo-mechanical analysis of cylinder heads must be coupled.

## References

- [1]. Azadi, M., Winter, G., Farrahi, G.H., Eichlseder, W. (2012). Design of cylinder head and block in international combustion engines based on fatigue strength of materials. *8th International Conference on Internal Combustion Engines and Oil*. Tehran.
- [2]. Gocmez, T., Pishinger, S. (2011). A contribution to the understanding of thermo-mechanical fatigue sensitivities in combustion engine cylinder heads. *Journal of Automobile Engineering*. vol. 225. p. 461-477.
- [3]. Li, J., Wang, P., Cui, X., Li, K., Yi, R. (2013). Gray Cast Iron Cylinder Head Thermal Mechanical Fatigue Analysis. *Proceedings of the FISITA 2012 World Automotive Congress Lecture Notes in Electrical Engineering*. vol. 189. p. 243-257.
- [4]. Metzger, M., Leidenfrost, M., Werner, E., Riedel, H., Seifert, T. (2014). Lifetime Prediction of EN-GJV 450 Cast Iron Cylinder Heads under Combined Thermo-mechanical and High Fatigue Loading. *SAE International Paper No.2014-01-9047*.
- [5]. Trampert, S., Gocmez, T., Pisinger, S. (2008). Thermo-mechanical fatigue life prediction of cylinder head in combustion engines. *Journal of Engineering for Gas Turbines and Power*. vol. 130. p. 1-10.
- [6]. Zahedi, F., Azadi, M. (2012). Low cycle fatigue life analysis of magnesium alloy diesel engine cylinder head. *20th Annual International Conference on Mechanical Engineering*. Shiraz.
- [7]. Takahashi, T., Sasaki K. (2010). Low cycle fatigue of aluminum alloy cylinder head in consideration of changing metrology microstructure. *Journal of Procedia engineering*. vol. 2. p. 767-776.
- [8]. Farrahi, G.H., Ghodrati, M., Azadi, M., Rezvani Rad, M. (2014). Stress-strain time-dependent behavior of A356.0 aluminum alloy subject to cyclic thermal and mechanical lading. *Journal of Mech Time-Depend Mater*. vol. 18. p. 475-491.
- [9]. Thomas, J.J., Vergner, L., Bignonnet, A., Borret, S.M. (2002). Thermo-mechanical design in the automotive industry. *SAE International Paper No.2002-01-0659*.
- [10]. Thomas, J.J., Vergner, L., Bignonnet, A., Charkaluk, E. (2004). Thermo-mechanical design in the automotive industry. *Journal of Fatigue and Fracture of Engineering Material and Structure*. vol. 27. p. 887-895.

- [11]. Shoja'efard, M.H., Ghaffarpour, M.R., Nourpour, A.R., Alizadenia, S. (2006). Thermo-mechanical Analysis of an Engine Cylinder Head. *Journal of Automotive Engineering*. vol. 220. p. 627-636.
- [12]. Quazi, M., Parashar, S. (2015). Effect of Thermal Bearing Coating on Performance and Emission of Off Road Vehicle. *SAE International, Paper No. 2015-26-0065*.
- [13]. Buyukkaya, E., Engin, T., Cerit, M. (2006). Effects of thermal barrier coating on gas emissions and performance of a LHR engine with different injection timings and valve adjustments. *Journal of Energy Conversion and Management*. vol. 47. p. 1298-1310.
- [14]. Danielson, E., Elwart, J., Bryzik, W., Turner, D. (1992). Thermomechanical analysis of low heat rejection cylinder head. *SAE International, Paper No. 920544*.
- [15]. Rupangudi, S., Ramesh, C., Veerabhadhrappa, K., V, R. (2014). Study of Effect of Coating of Piston on the Performance of a Diesel Engine. *SAE International Paper No. 2014-01-1021*.
- [16]. Modi, A. (2012). Experimental Study of Energy Balance in Thermal Barrier Coated Diesel Engine. *SAE International, Paper No. 2012-01-0389*.
- [17]. Ramu, P., Saravanan, C.G. (2009). Effect of ZrO<sub>2</sub>-Al<sub>2</sub>O<sub>3</sub> and SiC coating on diesel engine to study the combustion and emission characteristics. *SAE International Paper No.2009-01-1435*.
- [18]. Taymaz, I. (2007). The effect of thermal barrier coatings on diesel engine performance. *Journal of Surface and Coatings Technology*. vol. 201. p. 5249-5252.
- [19]. Hejwowski, T., Weronki, A. (2002). The effect of thermal barrier coatings on diesel engine performance. *Journal of Vacuum*. vol. 65. p. 427-432.
- [20]. Rezvani Rad, M., Farrahi, G. H., Azadi, A., Ghodrati, M. (2015). Stress analysis of thermal barrier coating system subjected to out-of-phase thermo-mechanical loadings considering roughness and porosity effect. *Journal of surface & coating technology*. vol. 262. p. 77-86.
- [21]. Moridi, A., Azadi, M., Farrahi, G.H. (2014). Thermo-mechanical stress analysis of thermal barrier coating system considering thickness and roughness effects. *Journal of surface and coating*. vol. 243. p. 91-99.
- [22]. Azadi, M., Balo, M., Farrahi, G.H., Mirsalim, S.M. (2013). A review of thermal barrier effects on diesel engine performance and components lifetime. *International Journal of Automotive Engineering*. vol. 3. p.305-317.
- [23]. Bialas, M. (2008). Finite element analysis of stress distribution in thermal barrier coating. *Journal of surface and coating*. vol. 202. p. 6002-6010.
- [24]. Slámečka, K., Čelko, L., Skalka, P., Pokluda, J., Němec, K., Juliš, M., Klakurková, L., Švejcar, J.(2015). Bending fatigue failure of atmospheric-plasma-sprayed CoNiCrAlY+ YSZ thermal barrier coatings. *International Journal of Fatigue*, vol. 70. p. 186-195.
- [25]. Kim, D. J., Shin, I.H., Koo, J.M., Seok, C.S., Lee, T.W.(2010). Failure mechanisms of coin type plasma-sprayed thermal barrier coatings with thermal fatigue. *Journal of Surface and Coatings Technology*. vol. 205. p. S451-S458.
- [26]. Kamo, R., Bryzik, W. (1978). Adiabatic turbo-compound engine performance prediction. *SAE International, Paper No.780068*.
- [27]. Kamo, R., Bryzik, W. (1979). Ceramics in heat engines. *SAE International, Paper No.790645*.
- [28]. Kamo, R., Bryzik, W. (1981). Cummins-TRADOCOM adiabatic turbo-compounded engine program. *SAE International, Paper No.810070*.
- [29]. Kamo, R., Bryzik, W. (1984). Cummins/TACOM advanced adiabatic engine. *SAE International, Paper No. 840428*.
- [30]. Sekar, R.R., Kamo, R. (1984). Advanced adiabatic diesel engine for passenger cars. *SAE International, Paper No. 840434*
- [31]. Kamo R., Woods, M.E., Bryzik, W. (1989).Thin thermal barrier coating for engines. *United States Patent, Patent No. US4852542*.
- [32]. Winkler, M.F., Parker, D.W., Bonar, J.A. (1992). Thermal barrier coatings for diesel engines: ten years of experience. *SAE International, Paper No. 922438*.
- [33]. Winkler, M.F., Parker, D.W. (1993). The role of diesel ceramic coatings in reducing automotive emissions and improving combustion efficiency. *SAE International, Paper No. 930158*.
- [34]. Arment, T., Cowart, J., Caton, P., Hamilton, L. (2010). The Effect of Ceramic Thermal Barrier Combustion Chamber Coatings on the Performance and Efficiency of a Small Diesel Engine. *SAE International, Paper No. 2010-32-0090*.
- [35]. Asghari, S., Salimi, M. (2010). Finite element simulation of thermal barrier coating performance under thermal cycling. *Journal of*

- Surface and Coatings Technology*. vol. 205. p. 2042-2050.
- [36]. Ranjbar-Far, M., Absi, J., Mariaux, G., Dubois, F. (2010). Simulation of the effect of material properties and interface roughness on the stress distribution in thermal barrier coatings using finite element method. *Journal of Materials and Design*. vol. 31. p. 772-781.
- [37]. Wang, L., Wang Y., Zhang, W.Q., Sun, X.G., He, J.Q., Pan, Z.Y., Wang, C.H. (2012). Finite element simulation of stress distribution and development in 8YSZ and double-ceramic-layer La<sub>2</sub>Zr<sub>2</sub>O<sub>7</sub>/8YSZ thermal barrier coatings during thermal shock. *Journal of Applied Surface Science*. vol. 258. p. 3540-3555.
- [38]. Cerit, M. (2011). Thermo mechanical analysis of a partially ceramic coated piston used in an SI engine. *Journal of Surface and Coatings Technology*. vol. 205. p. 3499-3505.
- [39]. Durat, M., Kapsiz, M., Nart, E., Ficici, F., Parlak, A. (2012). The effects of coating materials in spark ignition engine design. *Journal of material and design*. vol. 36. p. 540-545.
- [40]. Marr, M., Wallace, J., Memme, S., Chandra, S., Pershin, L., Mostaghimi, J. (2010). An Investigation of Metal and Ceramic Thermal Barrier Coatings in a Spark-Ignition Engine. *SAE International, Paper No.2010-01-2090*.
- [41]. Cerit, M., Coban, M. (2014). Temperature and thermal analysis of a ceramic-coated aluminum alloy piston used in a diesel engine. *International journal of thermal science*. vol. 77. p. 11-18.
- [42]. Saad, D., Saad, P., Kamo, L., Mekari, M., Bryzik, W., Tasdemir, J. (2007). Thermal barrier coatings for high output turbocharged diesel engine. *SAE International, Paper No.2007-01-1442*.
- [43]. Buyukkaya, E., Cerit, M. (2007). Thermal analysis of a ceramic coating diesel engine piston using 3-D finite element method. *Journal of surface & coating technology*. vol. 202. p. 398-402
- [44]. Du, S., Hu, X., Feng, Y., and Cheng, J. (2008). Thermal Analysis of Functional Gradient Materials as Thermal Barrier Coating of Piston. *SAE International, Paper No. 2008-01-2754*.
- [45]. Hejwowski, T. (2010). Comparative study of thermal barrier coating for internal combustion engine. *Journal of vacuum*. vol. 85. p. 610-612.
- [46]. Das, D., Majumdar, G., Sen, R.S., Ghosh, B. B. (2014). The Effects of Thermal Barrier Coatings on Diesel Engine Performance and Emission. *DOI 10.1007/s40032-014-0104-6*.
- [47]. Sivakumar, G., Kumar, S. (2014). Investigation on effect of yttria stabilized zirconia coated piston crown on performance and emission characteristic of diesel engine. *DOI.org/10.1016/j.aej.2014.08.003*.
- [48]. Ekström, M., Thibblin, A., Tjernberg, A., Blomqvist, C., Jonsson, S. (2015). Evaluation of internal thermal barrier coatings for exhaust manifolds. *Journal of surface & coating technology*. vol. 272. p. 198-212.
- [49]. Rezvani rad, M., Azadi M., Farrahi G.H. (2013). Thermal barrier coating effect on stress distribution of a diesel engine cylinder head. *7<sup>th</sup> Iranian Student Conference on Mechanical Engineering, School of Mechanical Engineering*. University of Tehran, Tehran,iran.
- [50]. Buyukkaya, E. (2008). Thermal analysis of functionally graded coating AlSi alloy and steel pistons. *Journal of surface & coating technology*. vol. 202. p. 3856-3865.
- [51]. Ashouri, H. (2015). Thermo-mechanical analysis of diesel engines cylinder heads using a two-layer viscoelasticity model with considering viscosity effects. *International Journal of Automotive Engineering*. vol. 5. p.1026-1038.
- [52]. Koch, F., Massan, F., Deuster, U., Loeprecht, M., Marckward, H. (1999). Low cycle fatigue of aluminum cylinder heads- Calculation and measurement of stain under fired operation. *SAE International Paper No.1999-01-0645*.
- [53]. Kichenin, J., Dang van, K., Boytard, K. (1996). Finite-element simulation of a new two-dissipative mechanisms model for bulk medium-density polyethylene. *Journal of material science*. vol. 32. p. 1653-1661.
- [54]. Deshpande, A., Leen, S.B., Hyde, T.H. (2010). Experimental and numerical characterization of the cyclic thermo-mechanical behavior of a high temperature forming tool alloy. *ASME Journal of Manufacturing Science and Engineering*. vol. 132. p. 1-12.
- [55]. Lemaitre, J., Chaboche, J. (1990). *Mechanics of Solid Materials*. Cambridge University Press, Cambridge.
- [56]. Chaboche, J. L. (1986). Time-independent constitutive theories for cyclic plasticity. *International Journal of Plasticity*. vol. 2. p. 149-188
- [57]. Chaboche, J. L. (2008). A review of some plasticity and viscoplasticity constitutive theories. *International Journal of Plasticity*. vol. 24. p. 1642-1693.
- [58]. Angeloni, M. (2011). Fatigue life evaluation of A356 aluminum alloy used for engine cylinder

- [59]. head. *Ph.D. Thesis, University of Sau Palu, Brazil.*
- [60]. Sun, G.Q., Shang, D.G.( 2010). Prediction Of Fatigue Lifetime Under Multiaxial Cyclic Loading Using Finite Element Analysis. *Journal of Material and Design.* vol. 31. p. 126-133.
- [61]. ABAQUS/CAE(v6.10-1).(, 2010). *User' s Manual.*
- [62]. Chamani H.R., Sattarifar I., Mohammadi Aghdam M.(2009). Study of effect combustion gases and cooling thermal boundary conditions on temperature distribution of a heavy diesel engine cylinder head, *Journal of engine research.* vol. 17. p. 71-81
- [63]. Wang, L., Y. Wang, Y., Sun, X.G., J.Q. He, J.Q., Z.Y. Pan, Z.Y., Wang, C.H.(2012). A novel structure design towards extremely low thermal conductivity for thermal barrier coatings –Experimental and mathematical study. *Materials and design.* vol. 35. p. 505-517.
- [64]. Kitazawa R., Tanaka M., Kagawa Y. and LiuY.F.( 2010). Damage evaluation of TBC system under in-phase thermo-mechanical tests. *Materials Science and Engineering.* vol. B173. p. 130-134
- [65]. Zhang Y.Y., Deng H.X., Shi H.J., Yu H.C. and Zhong B.(2012). Failure characteristic and life prediction for thermally cycled thermal barrier coatings. *Surface and Coatings Technology.* vol. 206. p. 2977-2985
- [66]. Nayeypashae, N., Seyedein, S. H., Aboutalebi, M.R., SarpoolakyH., Hadavi, S. M. M.(2015). Finite element simulation of residual stress and failure mechanism in plasma sprayed thermal barrier coatings using actual microstructure as the representative volume. *Journal of surface & coating technology.* vol. 291. p. 103-114
- [67]. Rezvani rad, M., Azadi M., Farrahi G.H.(2013). Thermal barrier coating effect on stress distribution of a diesel engine cylinder head, *7<sup>th</sup> Iranian Student Conference on Mechanical Engineering, School of Mechanical Engineering, University of Tehran.* Tehran,iran